

techno@wood

DESIGN ARCHITECTURE SYSTEMS

ALU

TECHNOWOOD Alu Profile
product details



GENERAL SPECIFICATIONS

TECHNOWOOD ALU PROFILE is a new product that brings the aesthetic of wood and resistance of aluminium composite together. It can be produced by covering all kinds of natural woods by using the technique of press profile to aluminium composite panel. TECHNOWOOD ALU PROFILE which removes all the outdoor disadvantages of wood and has totally natural wood appearance, is a new construction-decoration material that widens new horizons for architects and enables them to design the products that they are not able to produce from natural wood. TECHNOWOOD ALU PROFILE enables to produce the sidings especially in outer space have much more long-life than classical wood. The biggest advantage of TECHNOWOOD ALU PROFILE is its resistance to outer air conditions and its being light.



Difference from Wood and Wood-derived Materials : Deflection, cracking that occurs in wooden materials does not happen . It does not bleed resin, nor fluff varnish. It is not affected by wood worms, insects or fungi. Rot or rust does not occur.

Fire Resistance : A2 class fireproof.Does not support fire.Acts as a barrier against the flames.

Installation : Installation is easy and fast. No screws, bolts, nails or similar fittings are visible from the outside. Thanks to its special fuse, it can be installed with or without joint gaps.

Environmental Sensitivity : It is a recyclable, healthy and environmentally friendly product. Wood is used only on the visible surfaces. The water-based structure of the varnish used on the surface and its very low VOC amount (volatile organic compounds), it does not pose any threat to the environment or to human life. (Exterior wood varnish VOC limits set by the European Union is 130 grams per liter.)

Sizes : By using continuous process technology, it can be manufactured uninterrupted up to 7.5 meters. Standard size is 6 meters. For high-volume orders, custom sizes can be manufactured.

Varnish Color Options : There are standard 7 different color options, however for high-volume orders, special color work is possible. Water based varnish is used in the products.

Wood Coating Option : The standard wood coating options are afromosia teak, domestic walnut, American oak, mahogany, ash and beech. (Alpine coatings are not recommended for outdoors)

Guarantee : The products are guaranteed for delamination for 20 years, within the guarantee terms and conditions. On products exposed to sunlight, the color may decrease over time. In order to prevent discoloration, it is recommended to renew the varnishing with a water based varnish.



INSTALLATION INSTRUCTIONS

1- Main brackets and galvanized steel anchorages that are suitable for the measurements of the project are dowelled. Intermediary bracket is used between two main brackets. Bracket and anchorages are mounted to the building with M10x85 -110 rust-proof steel dowel at an adequate quantity. Main anchorages are mounted with 2 pieces of M10 dowels and intermediary anchorages are mounted with 1 piece of M10 dowels. (Dowels that are suitable for brackets to be mounted, should be used.) With respect to the distance between two brackets, it is not recommended for L_j to exceed 1,50 meters for the buildings that are at 100 meter of elevation and not to exceed 1,25 meters for the buildings that are longer than 100 meters.

2- Having regard to the vertical and horizontal scales of T profiles, 4,8 x 15 mm of wide head pop rivet or galvanized anchorages are mounted with M10x25 mm of rustproof steel cap screw and loaf or with cross-slotted cylindrical screw. The length of T profiles should not exceed the story height. Melding of two T profiles should be overlapped with the main brackets that are dowelled on the floor moldings. 1,5 cm of dilatation space should be given between two pieces of T profiles. Axle ranges of T profiles should be maximum 40 cm.

3- Air temperature should be between +10 and +35°C when **TECHNOWOOD ALU PROFILE** is activated. This temperature is the appropriate range in which the polyurethane based material will not lose its feature to provide a healthy bonding. Humidity rate of the environment should not be above 75%.

4- Double-sided bonding tape should be applied to all along vertical aluminium T profile from top to bottom uninterruptedly. A polyurethane adhesive with minimum 3 cm distance, at the form of a triangle at 8mm of wideness and at 10 mm of elevation should be again applied to all along T profile on the double-sided bonding tape and edges of aluminium T profile.



CLEANING AND CARE INSTRUCTIONS

- 1- For cleaning, a soft and damp cloth can be used. No cleaning liquid should be used in temperatures over 40°C. This can cause permanent plaque deposits to form over the paint.
- 2- The surface should not be cleaned with cleaning materials that contain alcohol and ammonia.
- 3- Before varnish treatment, it is essential that the surface is deprived from all kinds of foreign materials, oils, old paint residue, silicon and dust. A foam/sponge or 220 mm sandpaper can be used to do this.
- 4- With the help of a roller or brush, 2 or 3 coats of varnish is applied to the surface that is free of dust. The instructions given by the varnish producer should be complied with.
- 5- Ideal application temperature is between 15°C and 30°C. It is not recommended to be applied in temperatures below 10°C.
- 6- The relative humidity during the application should be below 80%. For maintenance, spring or summer months should be preferred.
- 7- Products that are exposed to sunlight can fade away in time. In order to prevent this, it is recommended to renew the varnishing, at least every 5 years, with water based varnish. This duration might be longer or shorter, depending on the duration of exposure to sunlight of the products.
- 8- If it is necessary to use a scaffolding or ladder for varnishing, necessary safety measures must be taken.
- 9- The disposal and/or recycling of the varnish/packaging of the applied varnish should be made in accordance with the legislations in power, preferably by a recognized collector or a certified company.
- 10- Keep the varnish that is used for maintenance away from children. Avoid eye or skin contact. In case of contact with eyes, rinse immediately with plenty of water and consult to a physician.





UNLOADING FROM THE VEHICLE

Necessary and appropriate tools should be used for the unloading of the materials that arrived at the workplace, and taking them to the storage area or directly to the installation area. Especially for the panels and profiles that are longer than 6 meters, by using necessary tools in proper settings, the risk of the materials being damaged during the process is minimized. If the length of the materials is between 6 to 8 meters, a forklift with wide arms should be used (3.5m), if the materials are below 6 meters, a forklift with narrow arms should be used (1.2 m). When the unloading is done with a forklift, one must be careful that the overflowing ends of the materials from the forklift should not exceed 2 to 2.5 meters.

1. Ropes that will be used should be nylon, hemp or silk, and should not be steel rope or chain. 2. In order for the ropes not to crush the corners of the materials, wooden chocks should be placed at the bottom and the top side of the stack, to where the ropes are. These chocks should exceed the panels at least 3 to 5 cm.

MANUAL STACKING

If the materials are taken from the stack at the site manually, to prevent the natural wooden coatings and panels from being scratched, the following issues should be considered:

- 1- Materials should not be pulled by grabbing from one end.
- 2- The materials when being carried to the site, should not be pulled or slid over the purlins.
- 3- When the materials are taken away from the stack or carried, if they are short ones (3-5 meters), they should be grabbed from both ends, if they are long materials (6 meters), they should be grabbed from both ends and in the middle also, keeping a balance.
- 4- While carrying the material, make sure that you do not step on another piece of material



STORAGE INSTRUCTIONS

Regardless of the duration of storage, while doing stacking, the following issues and measures should be taken into account:

- 1- Materials should be stacked over one another, no more than 1 meters in length.
- 2- Chock height should be 10 cm, and the distance between chocks should be at least 1.5 meters.
- 3- If there is a wooden pallet beneath the package, and if there are some materials protruding from the pallet, they should be supported with wooden chocks, the same height as the pallet itself.
- 4- The chocks in between the packages should be placed one on top of another, aligned in the same line.
- 5- Polyurethane or wooden chocks should be used only.
- 6- Never step on or walk over the stack or the panels that lie on the ground.
- 7- If the materials will be stored for a long time, their packages should be left open in order to prevent the dampening of the products.
- 8- The stacks should absolutely be kept in a covered warehouse, away from rain or humidity.

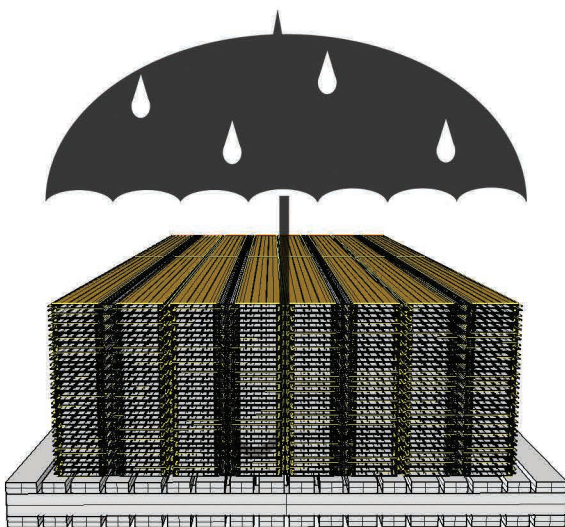

ALUMINUM MATERIAL SPECIFICATIONS

| COEFFICIENTS | VALUE | UNIT |
|-------------------|-------------------------|--|
| SPECIFIC WEIGHT | 2.71 | GR / CM3 |
| EXPANSION FACTOR | 23,4 X 0,000001 | 1 / C |
| ELASTICITY MODULE | 6900 | KG / MM2 |
| PULLING STRENGTH | 17,5 | 24 C DE KG 7 MM2 |
| ELONGATION | %8 | 24 C DE KG 7 MM2 |
| HARDNESS | 60-65 | BRINELL(HB) KG/ MM2 |
| YIELD STRENGTH | 14 | KG / MM2 |
| SHEAR STRENGTH | 13 | KG / MM2 |
| ALUMINUM ALLOY | AlMgSi0,5 6063 60 | DIN - ALMANYA BS- İNGİLTERE ETIAL -TÜRKİYE |

NATURAL WOOD COATING OPTIONS



AFROMOSIA TEAK



AMERICAN OAK



WALNUT



ASH

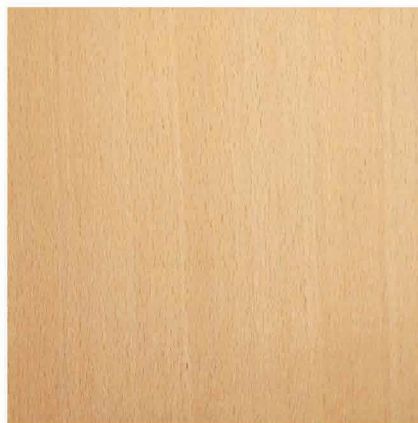

BEECH



MAHOGANY

TECHNOWOOD ALU PROFILE
VISUAL OF
FAÇADE PROFILE SYSTEM

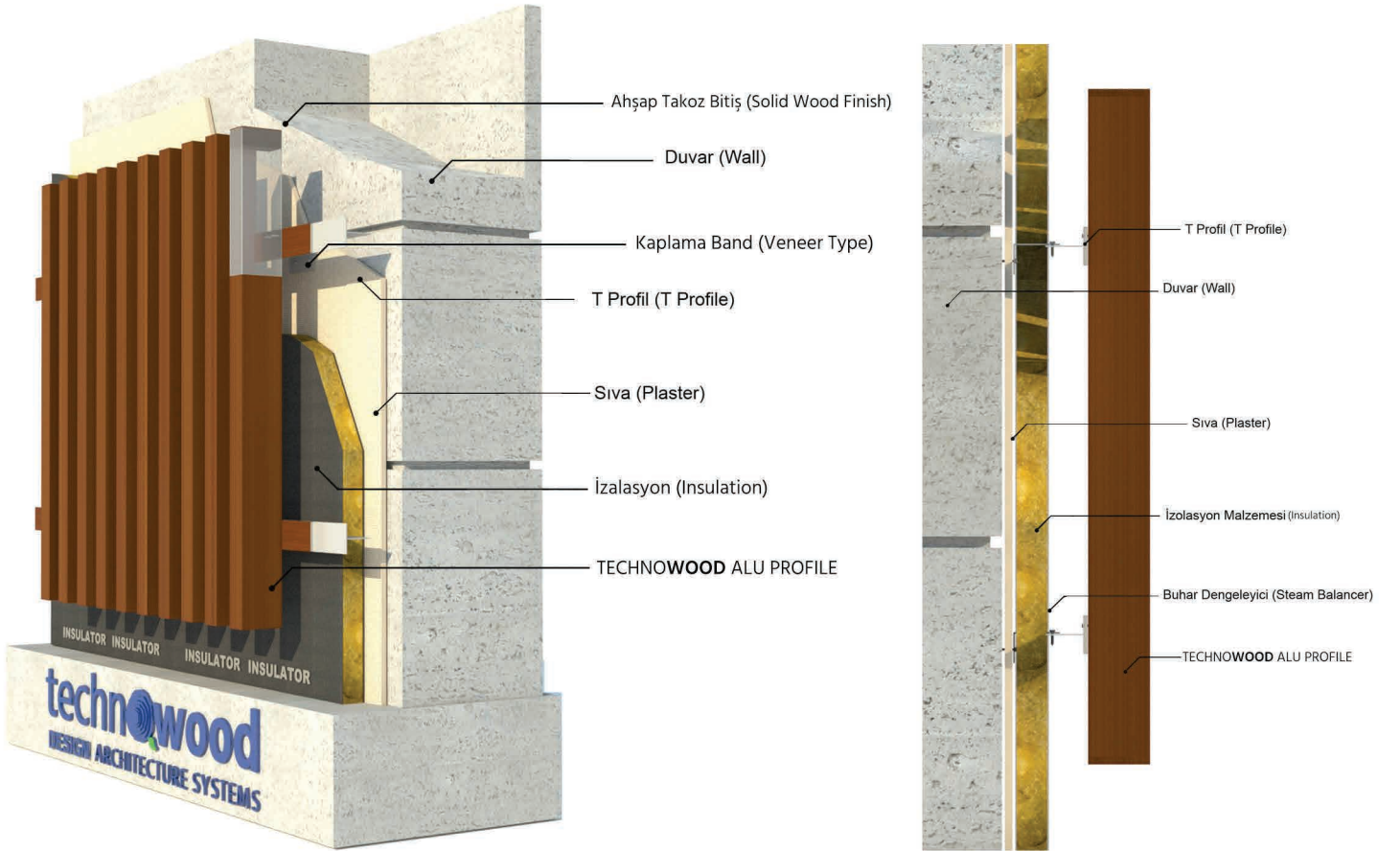

TECHNOWOOD ALU PROFILE



TECHNOWOOD ALU PROFILE
VISUAL OF
FAÇADE PROFILE SYSTEM

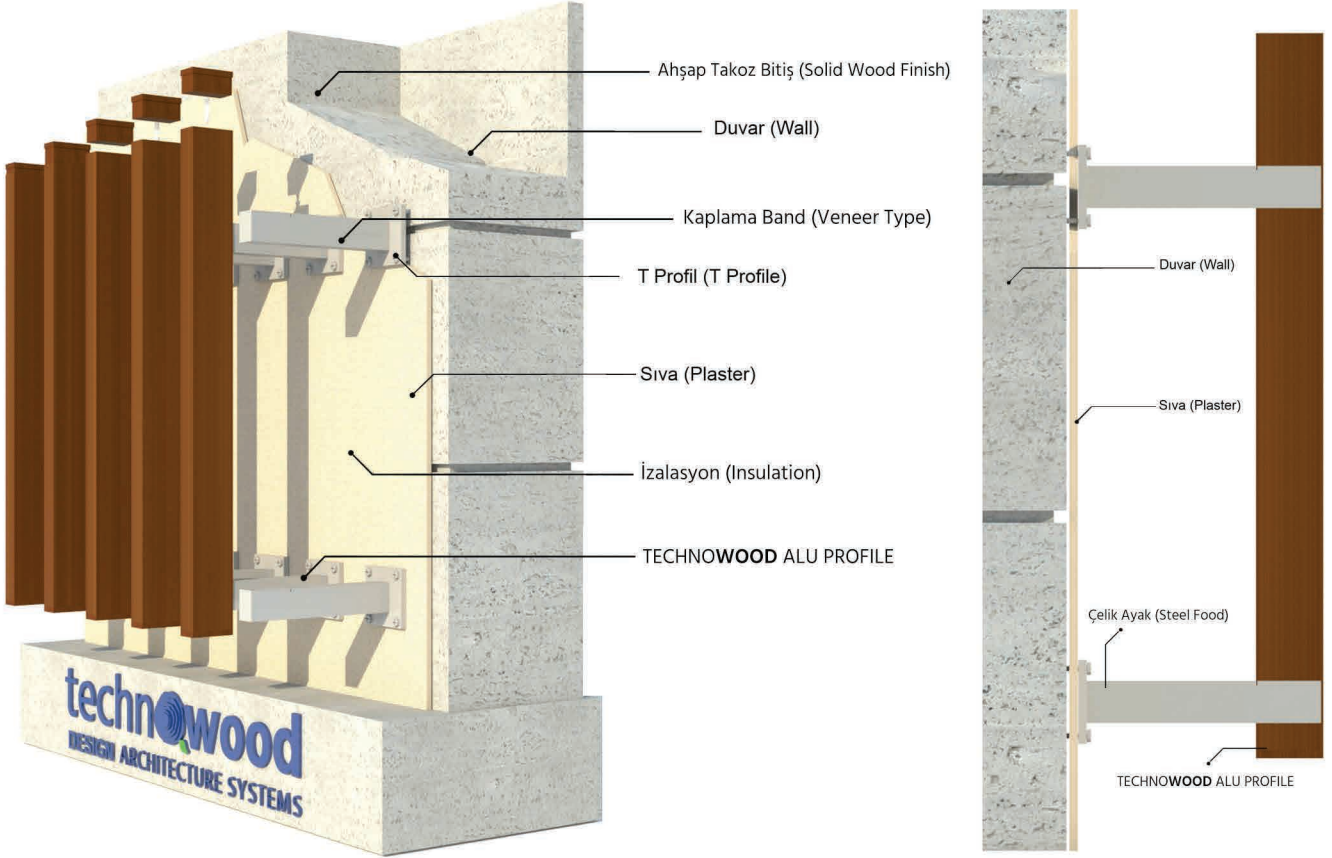

TECHNOWOOD ALU PROFILE



TECHNOWOOD ALU PROFILE
VISUAL OF
FAÇADE PROFILE SYSTEM

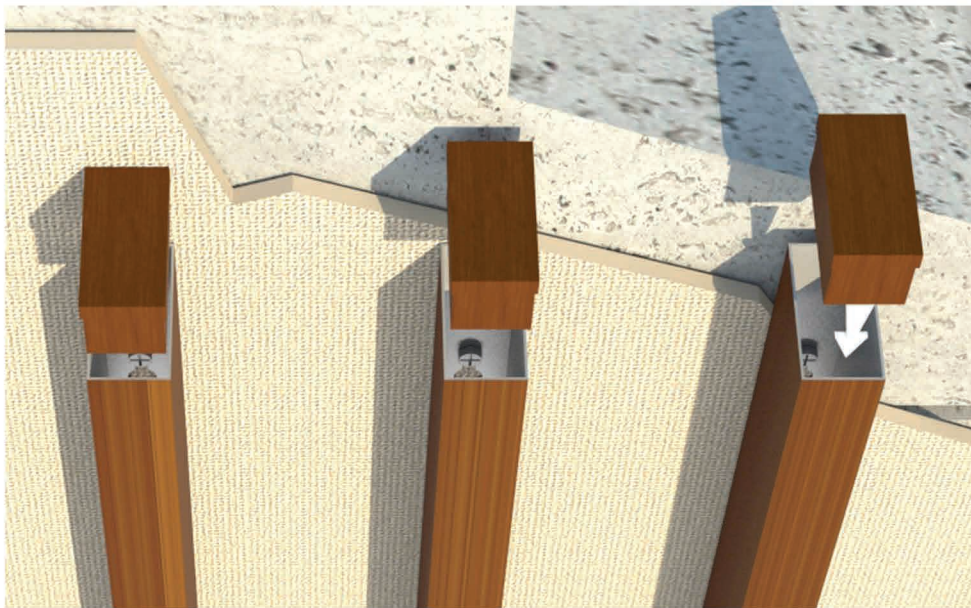

TECHNOWOOD ALU PROFILE
TECHNICAL VISUAL OF
FAÇADE PROFILE SYSTEM

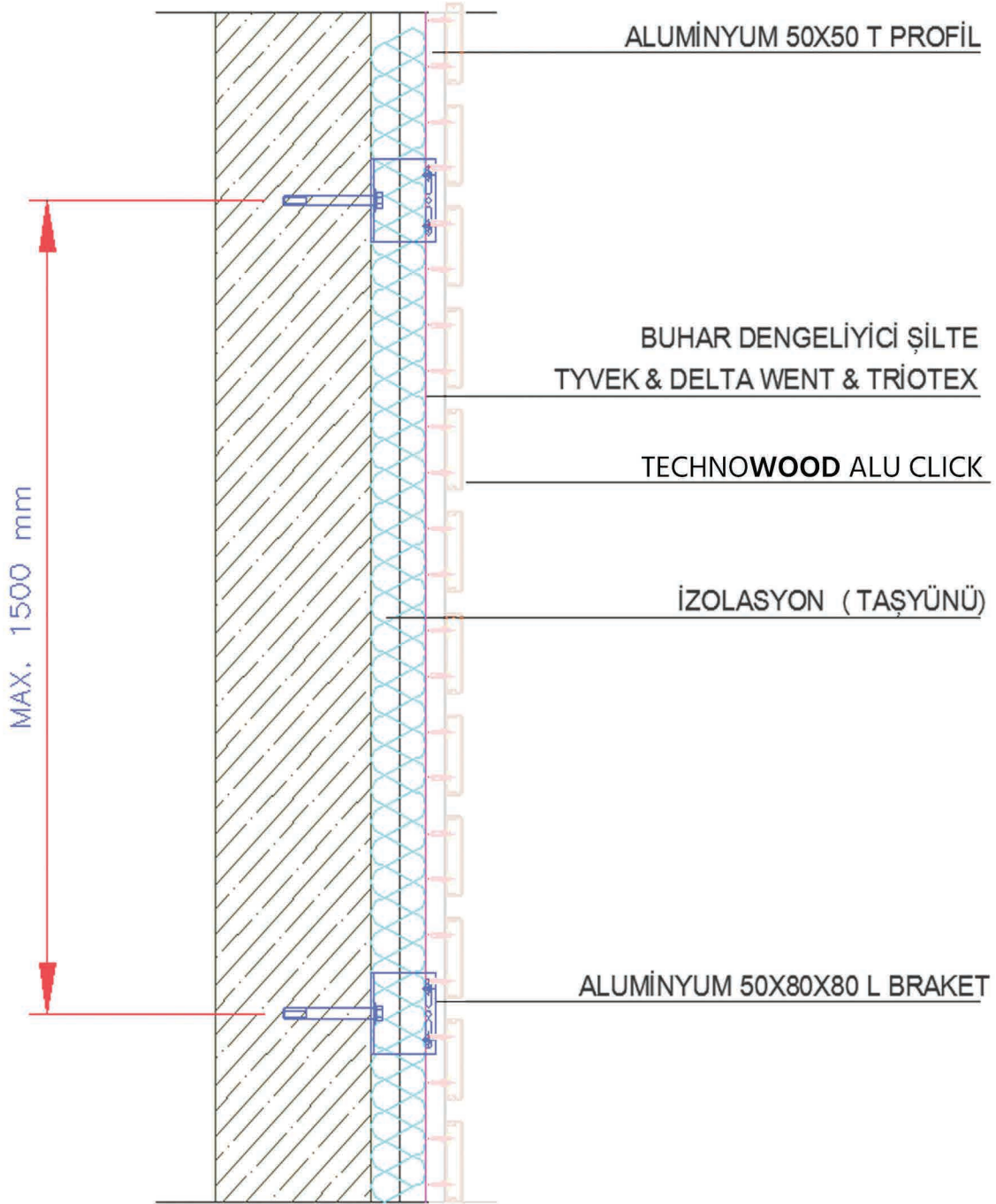

TECHNOWOOD ALU PROILE
TECHNICAL VISUAL OF
FAÇADE PROFILE SYSTEM



HIDDEN SPRING PIN CONNECTION DETAIL

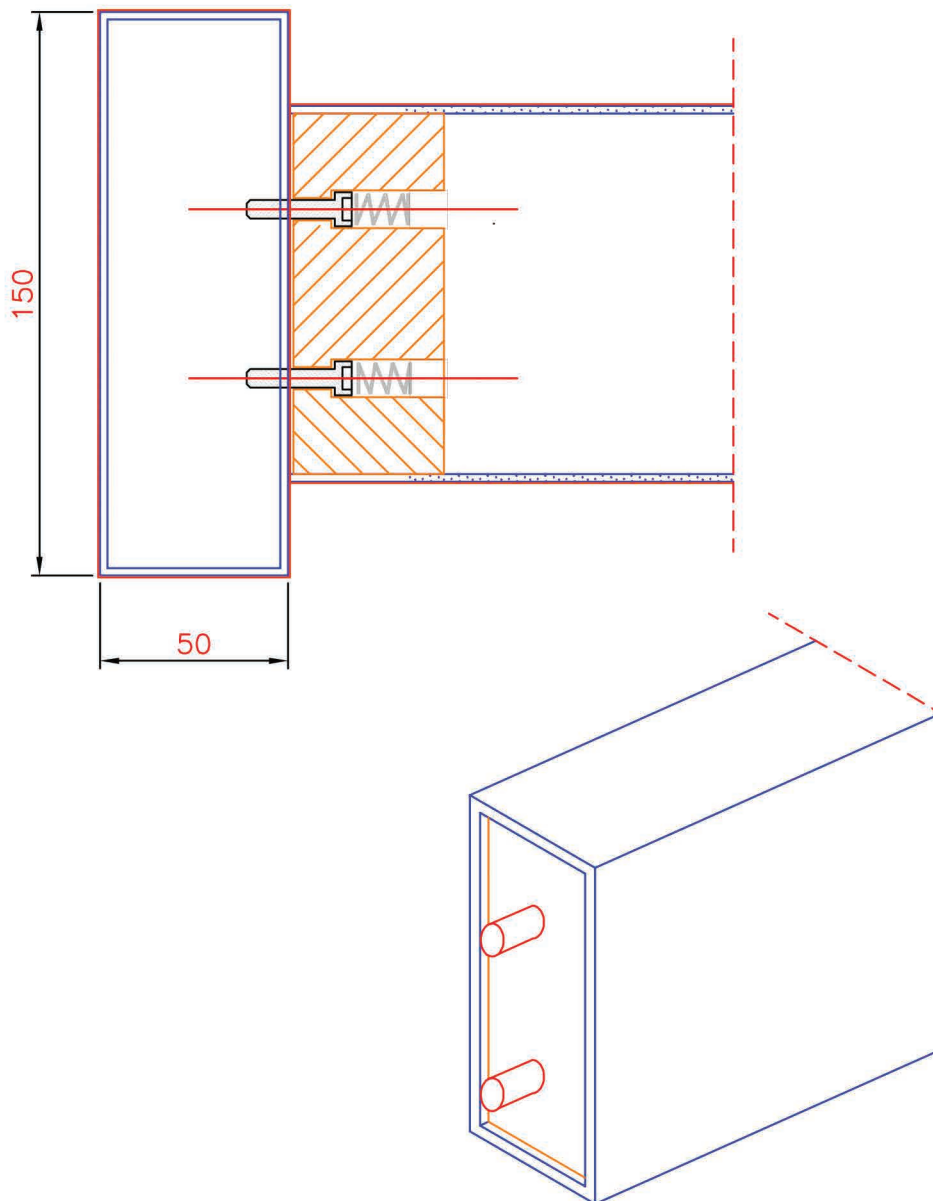

TECHNOWOOD ALU PROFILE
 SUB-CONSTRUCTION AND AUXILIARY PROFILES

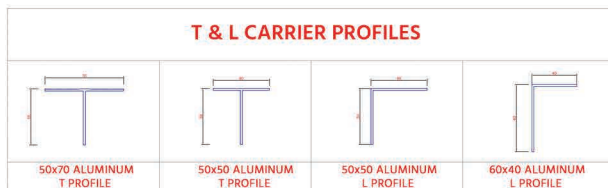
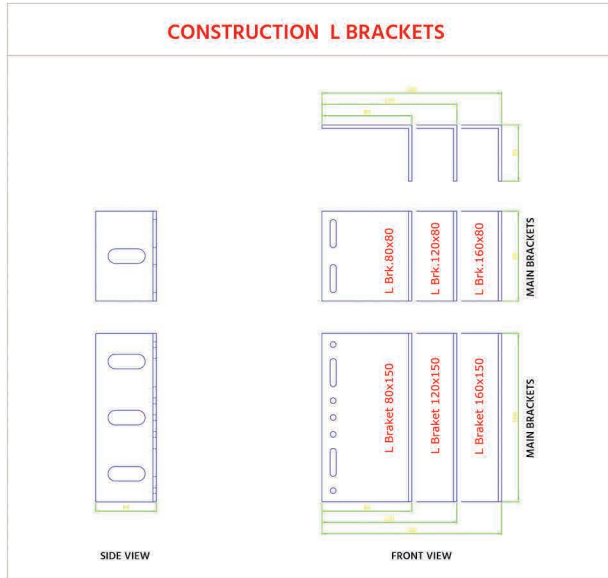

AUXILIARY PROFILES

| | | | |
|------------------------------|---------------------------------|--------------------------------|--------------------------------|
| | | | |
| CORNER PROFILE 1 | CORNER PROFILE 2 | CORNER PROFILE 3 | CORNER PROFILE 4 |
| | | | |
| INITIAL PROFILE 1 | INITIAL PROFILE 2 | CORNER PROFILE 5 | CORNER PROFILE 6 |
| | | | |
| COMBINATION PROFILE 1 | 30X30 OUTSIDE CORNER L PROFILE | 20X20 OUTSIDE CORNER L PROFILE | 15X15 OUTSIDE CORNER L PROFILE |
| | | | |
| COMBINATION PROFILE 2 | 30X30 INSIDE CORNER L PROFILE | 20X20 INSIDE CORNER L PROFILE | 15X15 INSIDE CORNER L PROFILE |
| | | | |
| JOINT SEALS WITH FUGA SYSTEM | JOINT SEALS WITHOUT FUGA SYSTEM | SIDING CONNECTION DEVICE | |

